



1038 TI-Adam Guidry Road
 Arnaudville, LA 70512
 Phone: (337) 754-5097
 Fax: (337) 754-7330

TRIM

NOTE: ALL TRIM 26 GA.

PAGE T14

SEE PRICE LIST

TRANSITION TRIM

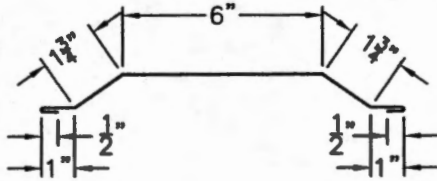

PART NUMBER

TT-1

GIRTH

12 1/2"

MAX. LENGTH

20'-6"

WT./FT.

.750#

EAVE TRIM (10" CHANNEL)

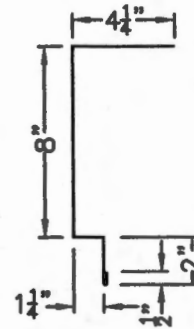

PART NUMBER

ET-10

GIRTH

16"

MAX. LENGTH

20'-6"

WT./FT.

.848#

HAT SECTION

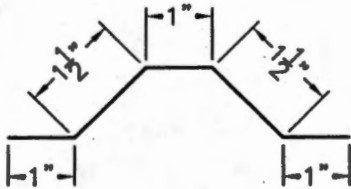

PART NUMBER

HS-1

GIRTH

6"

MAX. LENGTH

20'-6"

WT./FT.

.360#

10" CANOPY RAKE

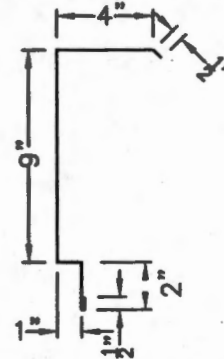

PART NUMBER

CR-10

GIRTH

17"

MAX. LENGTH

20'-6"

WT./FT.

.912#

BASE TRIM FOR SLAB WITH NO LEDGE

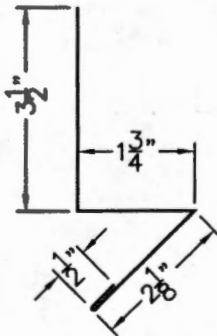

PART NUMBER

BT-1

GIRTH

7 7/8"

MAX. LENGTH

20'-6"

WT./FT.

.472#

PEAK BOX

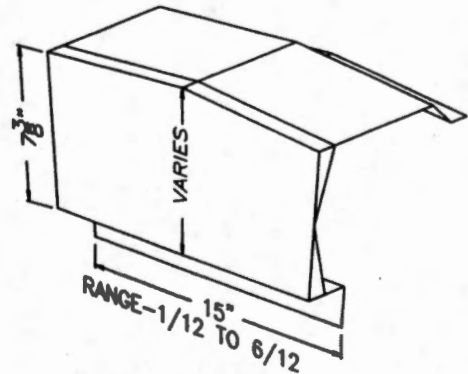

PART NUMBER

PB-2

GIRTH

MAX. LENGTH

WT.
2.16#
(1/12)

HIGHSIDE EAVE TRIM (4" CHANNEL)

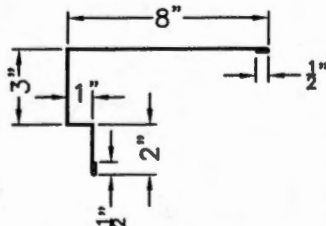

PART NUMBER

HSET-4

GIRTH

15"

MAX. LENGTH

20'-6"

WT./FT.

.897#

4" CANOPY RAKE FOR R PANEL

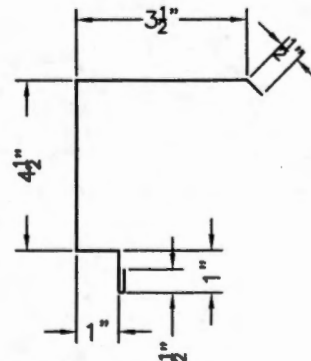

PART NUMBER

CR-4-1

GIRTH

11"

MAX. LENGTH

20'-6"

WT.

.660